

DEBEM
— HYGIENIC SOLUTIONS —

Sanitary pumps Hygienic Line



#unboxingdebem

Officially engaged
with performance.





#unboxingdebem

Index

4

Company

Debem

6

Aisiboxer and Saniboxer pumps

Main advantages

Patented pneumatic exchanger: unique in the market

Quick emptying system

[Aisiboxer -01, -02, -03](#)

[Saniboxer -01, -02, -03](#)

18

Aisiflux

Pulsation Dampeners

[Aisiflux](#)

20

Environmental sustainability



#unboxingdebem

Pump Your Needs

Debem

We're specialized in offering the best solutions for handling fluids in the food & beverage, pharmaceutical and cosmetic industry.

The HYGIENIC line includes different types of safe and versatile air-operated double diaphragm pumps, suitable to handle lots of fluids, even viscous or with solid parts inside.



Food & Beverage industry



Pharmaceutical industry



Cosmetic industry



#unboxingdebem



Aisiboxer / Saniboxer

Aisiboxer and Saniboxer pumps

Debem Hygienic line is composed of air-operated double diaphragm pumps (Aisiboxer and Saniboxer) designed and built to meet industry standards, including MOCA and FDA, and compliant with the Atex directive. They're manufactured in mechanically polished 316 L Stainless Steel, with sur-

face finish of less than $Ra < 0.8 \mu m$. These pumps are suitable for handling fluids in food&beverage, pharmaceutical and cosmetic industry. In the Saniboxer version they are 3A certified, so they are equipped with sensors for detect membrane rupture in order to avoid contamination during the opera-

tion. They can also handle fluids with high apparent viscosity or with solid suspended parts inside. Aisiboxer and Saniboxer pumps are suitable to be subjected to CIP/COP washing and SIP sanitization, with temperatures up to 130°C.

Main advantages

CLEANING AND MAINTENANCE EXTREMELY SIMPLE AND FAST

PATENTED STALL-PREVENTION COAXIAL PNEUMATIC EXCHANGER

SPECIAL DIAPHRAGMS WITH ANTI-DEPOSIT SURFACE

ECCENTRIC BALL VALVES



Advantages

Main advantages of Debem sanitary and food pumps

Special Diaphragms

Special anti-deposit surface

The anti-deposit surface of Debem diaphragms prevents product deposits and on the other hand allows a better flow.

Integrated plate

The diaphragms don't use fastening "caps"; the holding plate is integrated, this prevents the deposit of the product.

Coupled materials PTFE + EPDM

Debem diaphragms are manufactured with a food-grade PTFE cover and a support layer in EPDM. This type of diaphragm is durable and highly resistant to mechanical stress.

Main block

The main block is a fundamental part of the pump. The pneumatic exchanger is located in it. The main block of the Aisiboxer and Saniboxer pumps consists of a single (mould cast) piece in 316 L Stainless Steel with the same finish as casings and manifolds (mechanically polished and RA <math><0.8 \mu\text{m}</math>).

Anti-vibration feet

Anti-vibration feet dampen vibrations during pump operation. They are made of stainless steel and natural rubber and have a thread covered by a ring nut. They're available with 3A certification.

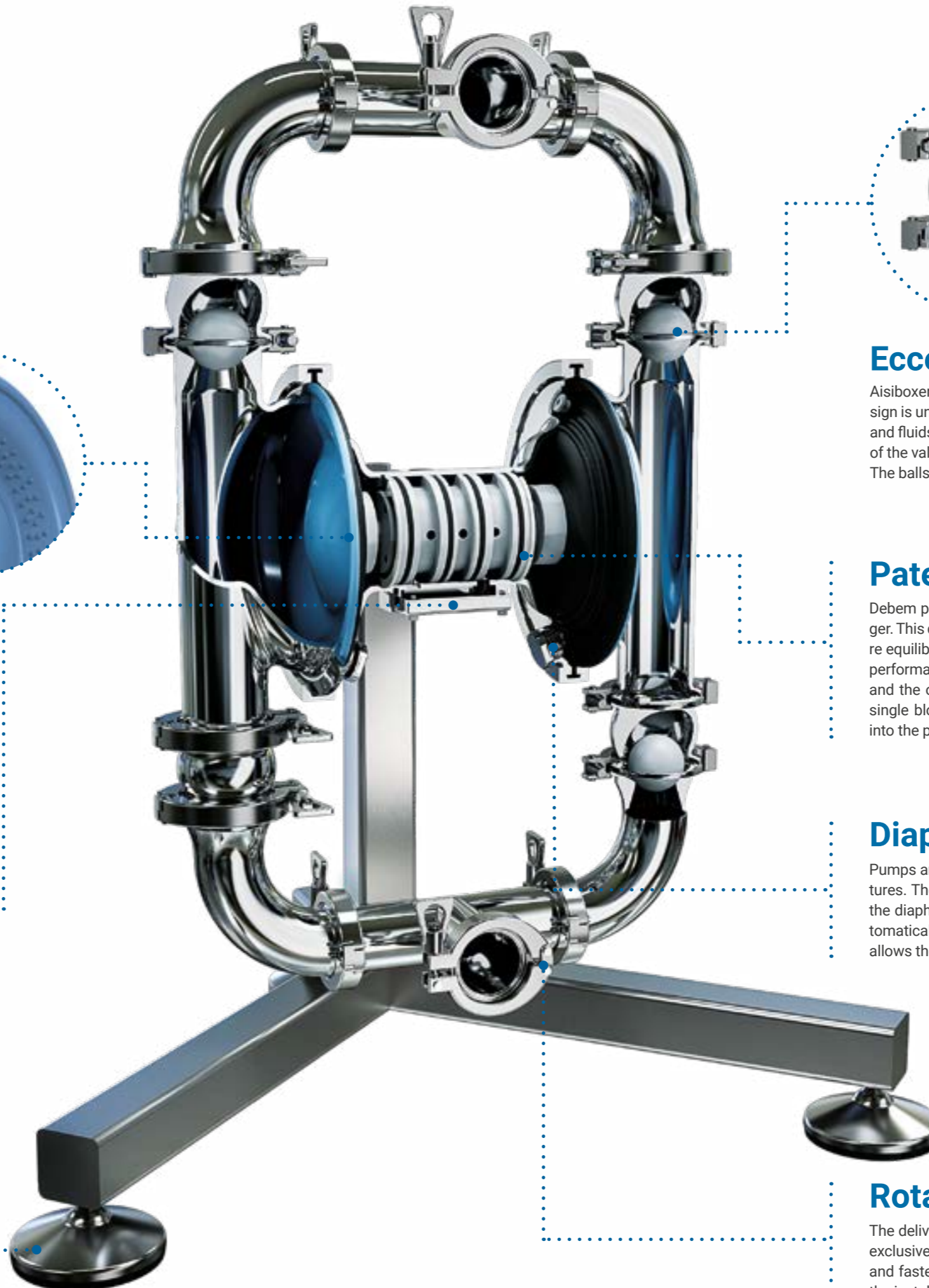

Eccentric ball valves

Aisiboxer and Saniboxer pumps are equipped with ball fluid valves. Their design is unique: the valve's eccentric circuit allows to handle higher flow rates and fluids with bigger suspended particles than the normal. The eccentricity of the valve body prevents the ball from locking during pumping operations. The balls are available in both SS-316 and PTFE.

Patented pneumatic exchanger

Debem pumps have a patented stall-prevention coaxial pneumatic exchanger. This device introduces compressed air to change the diaphragm pressure equilibrium, assisted by a stall-prevention circuit that guarantees optimal performance, even in the most critical conditions. The control part (spool) and the operating part (exchanger) are both housed inside the pump in a single block, which limits further load losses when compressed air flows into the pump.

Diaphragm rupture sensor

Pumps are equipped with two optical sensors to detect any diaphragm ruptures. The sensors are installed on the lower part of the pump just behind the diaphragm back. In case of rupture, sensors warn the operator and automatically stop pump operation via a solenoid valve. The control unit also allows the operator to instantly stop pump operation just touching a button.

Rotatable connections

The delivery and suction manifolds are made up of three pieces and joined exclusively by clamp connections, which make cleaning operations simpler and faster. The central connection can also be rotated 360°, depending on the installation requirement.

Debem patented pneumatic exchanger: unique in the market

Anti-stall system

The pneumatic exchanger introduces compressed air to alter the pressure balance of the diaphragms, helped by an anti-stall circuit which guarantees high performance even in more critical conditions.

Long-time device

Over 50,000,000 cycles.

Simple and minimal

Debem pneumatic exchanger is designed to be easily installed. It is even composed by a very limited number of pieces: this feature makes both maintenance and possible replacement extremely easy.

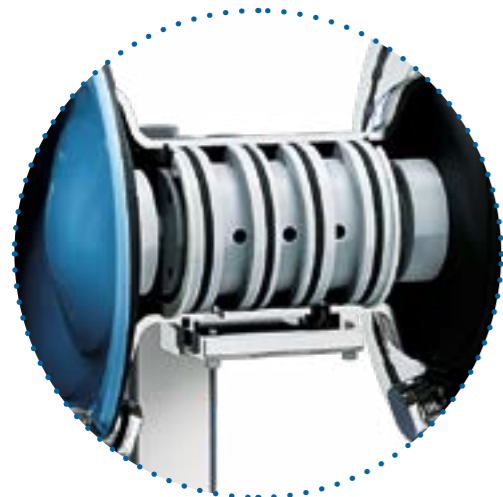

#unboxingdebem

Low air consumption

Spool and exchanger are both placed inside the central block, which further limits load losses while the compressed air flows into the pump. Debem pumps are designed with an optimisation of the spaces on the back of the diaphragms, in such a way as to guarantee the total expansion of the diaphragms with very content air volumes.

Pre-Lubricated System

Debem pneumatic exchanger is already lubricated with FDA grease, so the compressed air put into the pump doesn't need additional lubrication.

Quick emptying system

The quick emptying system allows the complete emptying of the pump from the fluid present inside the chambers.

The stand allows the pump to be rotated 360°, making the operation extremely simple and quick. The operation can be carried out comfortably by hand without the use of tools or special equipment.

The pump will thus be free of internal impurities and ready to be washed and sanitized.



Aisiboxer 01



Specifications and types

Suction/delivery connections	BS 4825 1" Clamp
Air fitting	3/8" f BSPP
Max flow rate*	100 l/min
Max air supply pressure	8 bar
Max head	80 m
Max suction from negative head – dry running*	2,5 m
Max suction from negative head – with pump on	9,5 m
Max diameter of suspended solids	5 mm

*The value depends on the pump configuration.

Performance curves

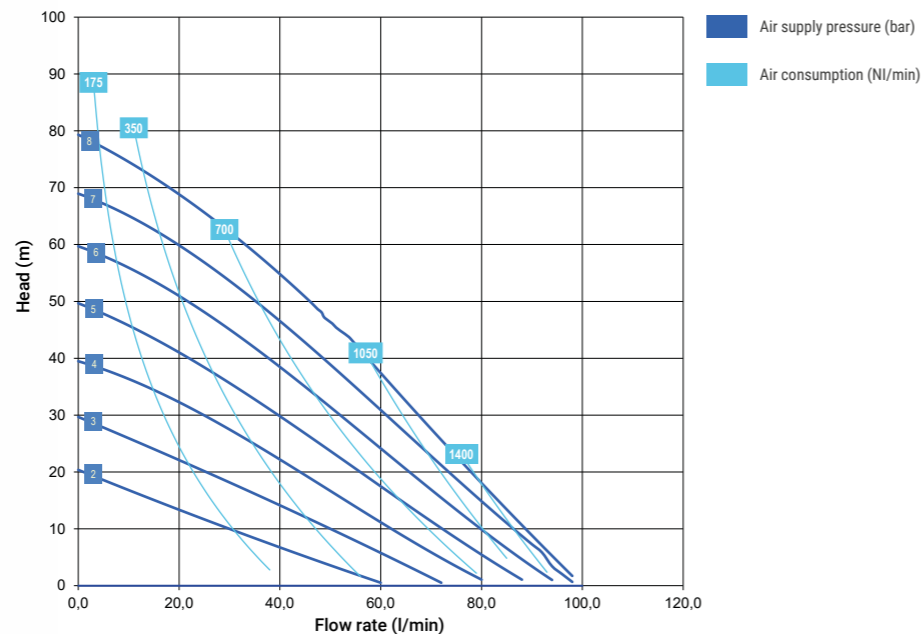

*The curves and performances refer to pumps with submerged suction and free delivery outlet, with water at 20° and vary according to the composition materials

AISI 316 L

Maximum dimensions

Height	599 mm
Width	412 mm
Depth	318 mm

Construction materials (casing and manifolds) and net weight

AISI 316 L**	16 Kg
	Temp. 3°C min.
	95°C max

* Warning on process temperatures: for washing and sanitisation, the pumps can be subjected to CIP, COP and SIP with temperatures up to 130 °C.

**Mechanically polished – surface finish < 0.8 µm



#unboxingdebem

Aisiboxer 02



Specifications and types

Suction/delivery connections	BS 4825 1"1/2 Clamp
Air fitting	3/8" f BSPP
Max flow rate*	160 l/min
Max air supply pressure	8 bar
Max head	80 m
Max suction from negative head – dry running*	2,5 m
Max suction from negative head – with pump on	9,5 m
Max diameter of suspended solids	7 mm

*The value depends on the pump configuration.

Performance curves

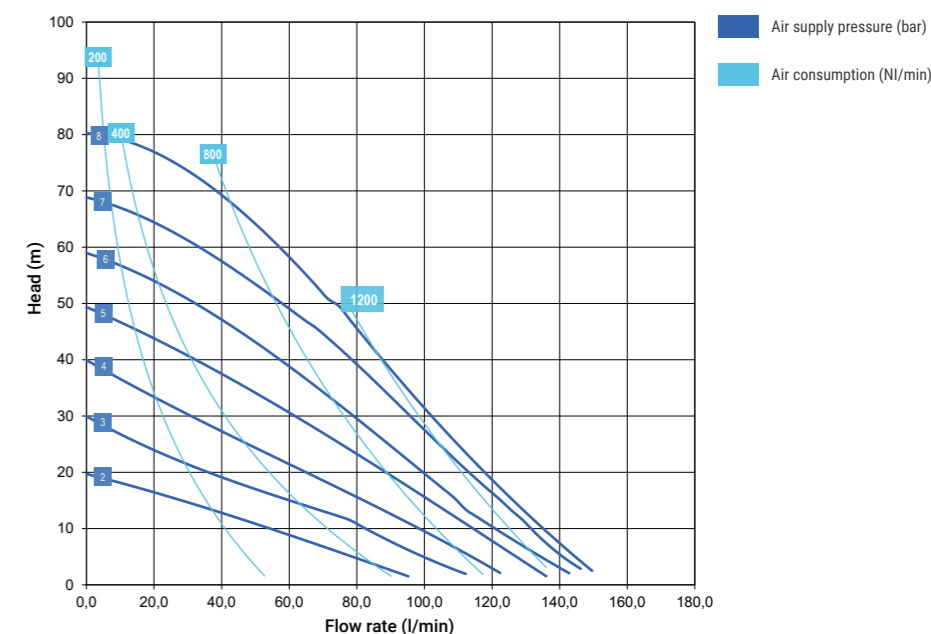

*The curves and performances refer to pumps with submerged suction and free delivery outlet, with water at 20° and vary according to the composition materials

AISI 316 L

Maximum dimensions

Height	650 mm
Width	412 mm
Depth	318 mm

Construction materials (casing and manifolds) and net weight

AISI 316 L**	22 Kg
	Temp. 3°C min.
	95°C max

* Warning on process temperatures: for washing and sanitisation, the pumps can be subjected to CIP, COP and SIP with temperatures up to 130 °C.

**Mechanically polished – surface finish < 0.8 µm

Aisiboxer 03



Specifications and types

Suction/delivery connections	BS 4825 2" Clamp
Air fitting	1/2" f BSPP
Max flow rate*	340 l/min
Max air supply pressure	8 bar
Max head	80 m
Max suction from negative head – dry running*	2,5 m
Max suction from negative head – with pump on	9,5 m
Max diameter of suspended solids	15 mm

*The value depends on the pump configuration.

Performance curves

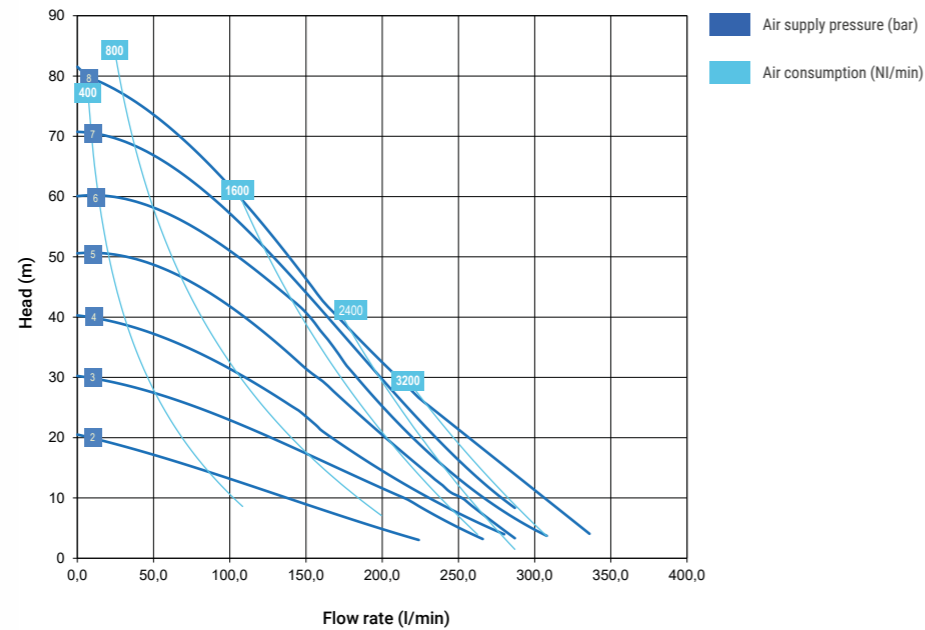

*The curves and performances refer to pumps with submerged suction and free delivery outlet, with water at 20° and vary according to the composition materials

AISI 316 L

Maximum dimensions

Height	812 mm
Width	683 mm
Depth	539 mm

Construction materials (casing and manifolds) and net weight

AISI 316 L**	38 Kg
	Temp. 3°C min.
	95°C max

* Warning on process temperatures: for washing and sanitisation, the pumps can be subjected to CIP, COP and SIP with temperatures up to 130 °C.

**Mechanically polished – surface finish < 0.8 µm



#unboxingdebem

Saniboxer 01



Specifications and types

Suction/delivery connections	BS 4825 1" Clamp
Air fitting	3/8" f BSPP
Max flow rate*	100 l/min
Max air supply pressure	8 bar
Max head	80 m
Max suction from negative head – dry running*	2,5 m
Max suction from negative head – with pump on	9,5 m
Max diameter of suspended solids	5 mm

*The value depends on the pump configuration.

Performance curves

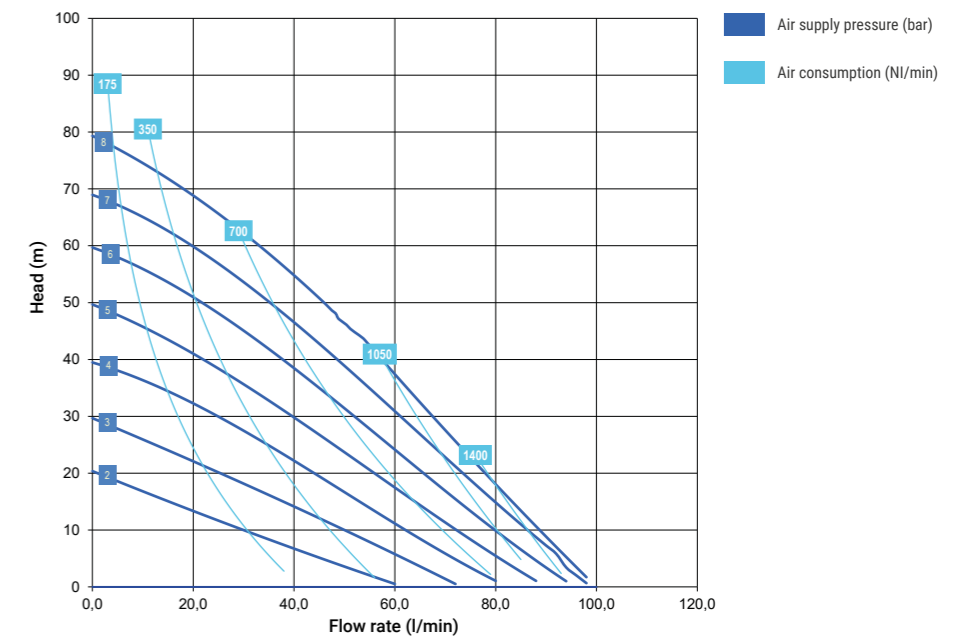

*The curves and performances refer to pumps with submerged suction and free delivery outlet, with water at 20° and vary according to the composition materials

AISI 316 L

Maximum dimensions

Height	656 mm
Width	437 mm
Depth	343 mm

Construction materials (casing and manifolds) and net weight

AISI 316 L**	16 Kg
	Temp. 3°C min.
	95°C max

* Warning on process temperatures: for washing and sanitisation, the pumps can be subjected to CIP, COP and SIP with temperatures up to 130 °C.

**Mechanically polished – surface finish < 0.8 µm



#unboxingdebem



Specifications and types

Suction/delivery connections	BS 4825 1 1/2 Clamp
Air fitting	3/8" f BSPP
Max flow rate*	160 l/min
Max air supply pressure	8 bar
Max head	80 m
Max suction from negative head – dry running*	2,5 m
Max suction from negative head – with pump on	9,5 m
Max diameter of suspended solids	7 mm

*The value depends on the pump configuration.

Performance curves

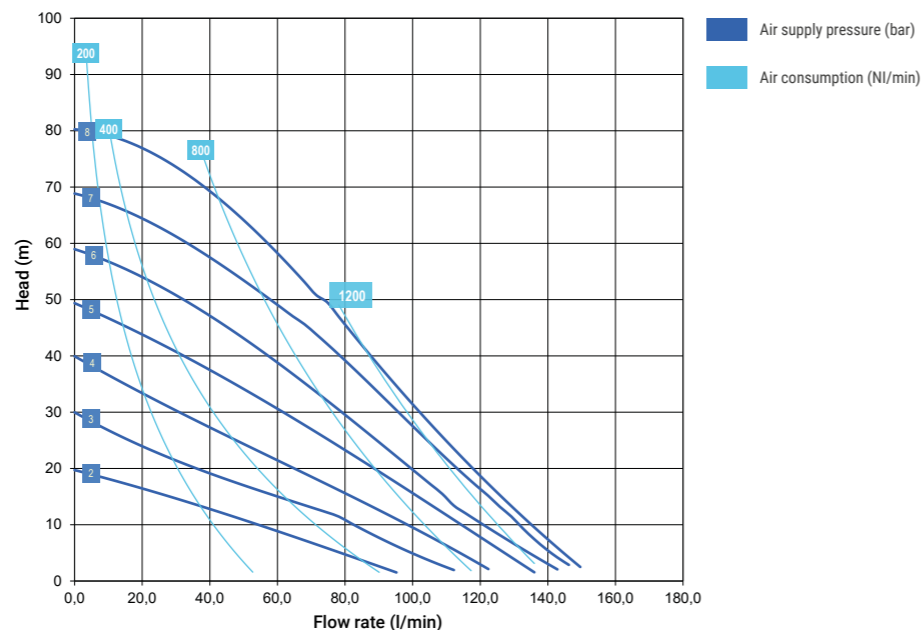

*The curves and performances refer to pumps with submerged suction and free delivery outlet, with water at 20° and vary according to the composition materials

AISI 316 L

Maximum dimensions

Height	707 mm
Width	437 mm
Depth	343 mm

Construction materials (casing and manifolds) and net weight

AISI 316 L**	22 Kg
	Temp. 3°C min.
	95°C max

* Warning on process temperatures: for washing and sanitisation, the pumps can be subjected to CIP, COP and SIP with temperatures up to 130 °C.

**Mechanically polished – surface finish < 0.8 µm

Saniboxer 02



Specifications and types

Suction/delivery connections	BS 4825 2" Clamp
Air fitting	1/2" f BSPP
Max flow rate*	340 l/min
Max air supply pressure	8 bar
Max head	80 m
Max suction from negative head – dry running*	2,5 m
Max suction from negative head – with pump on	9,5 m
Max diameter of suspended solids	15 mm

*The value depends on the pump configuration.

Performance curves

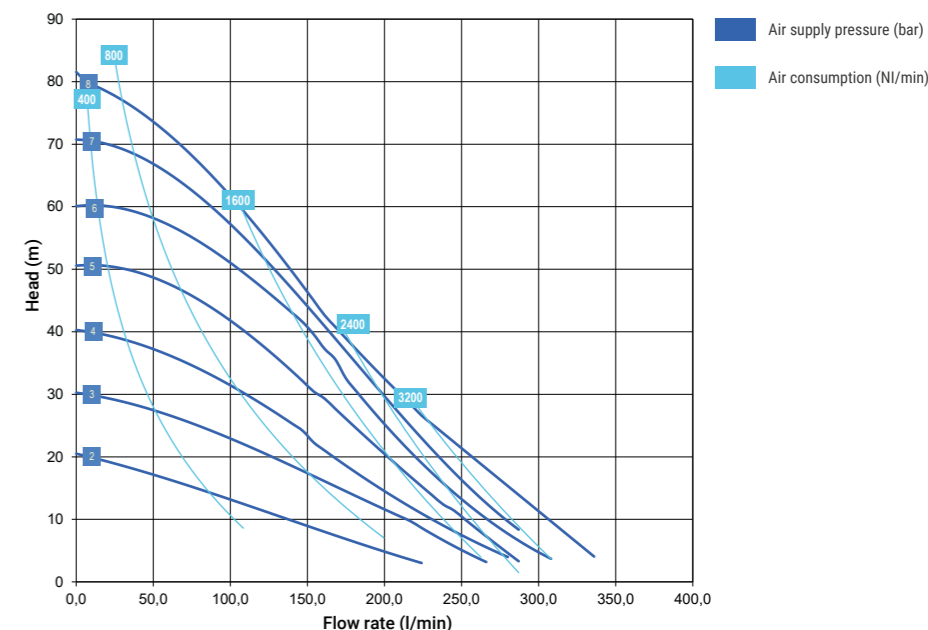

*The curves and performances refer to pumps with submerged suction and free delivery outlet, with water at 20° and vary according to the composition materials

AISI 316 L

Maximum dimensions

Height	874 mm
Width	673 mm
Depth	529 mm

Construction materials (casing and manifolds) and net weight

AISI 316 L**	39 Kg
	Temp. 3°C min.
	95°C max

* Warning on process temperatures: for washing and sanitisation, the pumps can be subjected to CIP, COP and SIP with temperatures up to 130 °C.

**Mechanically polished – surface finish < 0.8 µm

Saniboxer 03





#unboxingdebem



Aisiflux

Pulsation Dampeners

Aisiflux pulsation dampeners are designed for food and pharmaceutical applications, for fluids with high apparent viscosity, even with suspended solid particles inside. These devices automatically adapt to the conditions of the system without requiring manual adjustment or calibration interventions. Thanks to their high capacity to reduce pulsations, Aisiflux dampeners are suitable to preserve the integrity

of the system and guarantee a regular delivery. The materials of construction in contact with the fluid are 316 L Stainless steel (mechanically polished with surface finish < 0,8µm) and food grade PTFE.

Aisiflux dampeners work with the same compressed air that feeds the pump. Air is introduced into the back pressure chamber, located behind the

diaphragm, creating a cushion of pneumatic damping that automatically adjusts based on stresses caused by the pressure pulses generated by the pump.

Specifications

COMPLIANT WITH 1935/2004 AND FDA

SUITABLE FOR ATEX ATMOSPHERE

SUITABLE FOR CIP/COP CLEANINGS AND SIP SANIFICATIONS





#unboxingdebem

Sustainability

A concrete commitment, in line with planet needs



Sustainable energy, positive impact

We embrace solar energy as the primary source of energy. The solar panels installed on our structure allow us to generate clean energy and significantly reduce CO2 emissions.



Page reduction, zero compromises

We have reduced the size of our catalog and trimmed some non-essential pages to reduce paper usage. However, this has not compromised the quality of the information provided.



At the heart of our corporate philosophy

We create internal programs that stimulate energy conservation, responsible use of resources and the promotion of sustainable practices to spread eco-friendly practices throughout the company.



Our commitment is just the beginning

We are aware that our commitment to sustainability is just the beginning of a long journey. We want to involve our partners and customers in this vision, to take a step forward towards a greener future.

Web and contacts

Visit our website to learn more about all the products and their characteristics.

The new mobile responsive website is available in English, German, French, Italian, Spanish.



DEBEM Srl

Via Del Bosco, 41 21052 Busto Arsizio (VA)
Italy



Call us

+39 0331 074034



Send us an e-mail

info@debem.it



DEBEM DEUTSCHLAND GmbH

Bergfeldstraße 1, 83607 Holzkirchen
Deutschland



Call us

+49 8024 4602744



Send us an e-mail

info@debem.de



Visit the website

www.debem.com



Follow us on LinkedIn

debem



#unboxingdebem



DEBEM Srl

Via Del Bosco, 41
21052 Busto Arsizio (VA)
Italy
www.debem.com

